

Instruction Manual

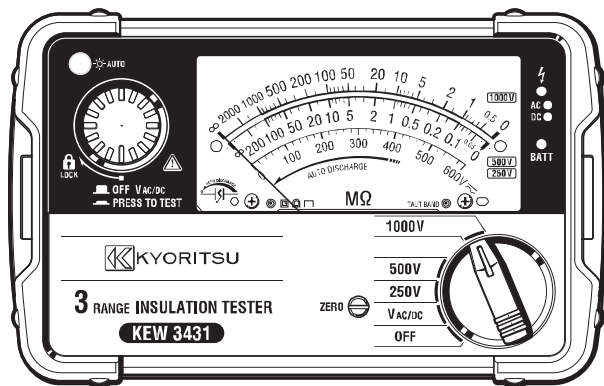

Compact Insulation resistance tester

KEW3431



**KYORITSU ELECTRICAL
INSTRUMENTS WORKS, LTD.**

Contents

1. Safety warnings	1
2. Features	5
3. Specifications	6
4. Instrument layout	9
5. Accessories	11
6. Getting started	12
6-1 Mechanical zero adjustment	12
6-2 Attaching metal tip/ adapter to test leads	12
6-3 Battery voltage check	13
7. Voltage measurement	14
7-1 Measurement method	14
8. Insulation resistance measurement	15
8-1 Measurement method	18
8-2 Continuous measurement	19
8-3 Output voltage characteristics	20
8-4 LED insulation status indicator	21
9. Scale light and LED light	22
10. How to disable LED insulation status indicator & auto-lighting	23
11. Battery replacement	25
12. Shoulder strap belt attachment	26
13. Storing in Carrying case	27
14. Cleaning meter cover	28

1. Safety warnings

This instrument has been designed, manufactured and tested according to IEC 61010: Safety requirements for Electronic measuring apparatus, and delivered in the best condition after passing quality control tests.

This instruction manual contains warnings and safety rules which have to be observed by the user to ensure safe operation of the instrument and to maintain it in safe condition. Therefore, read through these operating instructions before starting to use the instrument.

⚠ DANGER

- Read through and understand the instructions contained in this manual before starting to use the instrument.
- Keep the manual at hand to enable quick reference whenever necessary
- The instrument is to be used only in its intended applications.
- Understand and follow all the safety instructions contained in the manual.

It is essential that the above instructions are adhered to. Failure to follow the above instructions may cause injury, instrument damage and/or damage to equipment under test. Kyoritsu is by no means liable for any damage resulting from the instrument in contradiction to these cautionary notes.

The symbol ⚠ indicated on the instrument, means that the user must refer to the related parts in the manual for safe operation of the instrument. It is essential to read the instructions wherever the symbol appears in the manual.

- ⚠ **DANGER** : is reserved for conditions and actions that are likely to cause serious or fatal injury.
- ⚠ **WARNING** : is reserved for conditions and actions that can cause serious or fatal injury.
- ⚠ **CAUTION** : is reserved for conditions and actions that can cause injury or instrument damage.

⚠ DANGER

- Never make measurements on circuits in which earth potentials higher than 600 V exist.
- KEW3441 is a CAT III-rated instrument. Do not make measurements under the circumstances exceeding the designed measurement category.
- Do not attempt to make measurements in the presence of flammable gasses. Otherwise the use of the instrument may cause sparking, which can lead to an explosion.
- Never attempt to use the instrument if its surface or your hand is wet.
- Be careful not to short-circuit the power line with the metal part of the test lead during a measurement. It may cause personal injury.
- Do not exceed the maximum allowable input of any measuring range.
- Never open the battery compartment cover during a measurement.
- The instrument should be used only in its intended applications or conditions. Otherwise, safety functions equipped with the instrument do not work, and instrument damage or serious personal injury may be caused.
- Verify proper operation on a known source before use or take action as a result of the indication of the instrument.

⚠ WARNING





- Never attempt to make any measurements if any abnormal conditions, such as a broken cover or exposed metal parts are present on the instrument and test leads.
- Ensure that the test leads are firmly connected to the instrument, and then press the test button.
- Do not install substitute parts or make any modifications to the instrument. Return the instrument to your local KYORITSU distributor for repair or re-calibration in case of suspected faulty operation.
- Do not try to replace batteries if the surface of the instrument is wet.
- Connect the test leads firmly into each terminal.
- Set the function switch to OFF position when opening the battery compartment cover for battery replacement.
- Never rotate the function switch with the test leads connected to the equipment under test.

⚠ CAUTION

- Always make sure to set the function switch to the appropriate position before making a measurement.
- Power off the instrument after use. Remove batteries if the instrument is to be stored and will not be in use for a long period.
- Do not expose the instrument to direct sunlight, high temperature, humidity or dew.
- Use a damp cloth with neutral detergent or water for cleaning the instrument. Do not use abrasives or solvents.
- This instrument is not water-proof. Do not let the instrument get wet with water; otherwise it may cause malfunction.
- If the instrument is wet, make sure to let it dry before putting it into storage.
- Keep your hand and fingers behind the barrier during a measurement.

Symbols

The following symbols are used and marked on the instrument and in the instruction manual. Please carefully check before starting to use the instrument.

CATⅢ	Primary electrical circuits of the equipment connected directly to the distribution panel, and feeders from the distribution panel to outlets.
	Double or reinforced insulation
	User must refer to the explanations in the instruction manual.
	Earth
	Danger of possible electric shock

Measurement Category

To ensure safe operation of measuring instruments, IEC 61010 establishes safety standards for various electrical environments, categorized as 0 to CAT IV, and called measurement categories. Higher-numbered categories correspond to electrical environments with greater momentary energy, so a measuring instrument designed for CAT III environments can endure greater momentary energy than one designed for CAT II.

0 : Circuits which are not directly connected to the mains power supply.

CAT II : Electrical circuits of equipment connected to an AC electrical outlet by a power cord.

CAT III : Primary electrical circuits of the equipment connected directly to the distribution panel, and feeders from the distribution panel to outlets.

CAT IV : The circuit from the service drop to the service entrance, and to the power meter and primary over-current protection device (distribution panel).

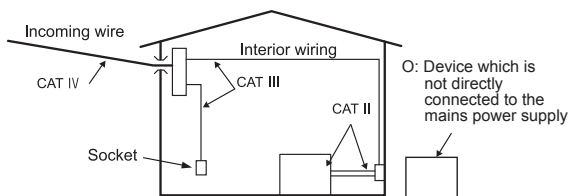

2. Features

KEW3431 can measure insulation resistance and also AC/DC voltage on low-voltage installations of 600V or less.

- Designed to meet the following safety standards
 - IEC 61010-1, IEC 61010-2-030 CAT III 600V Pollution degree 2
 - IEC 61010-031
- Compact and lightweight design
- Scale light and LED spot light to facilitate working at dimly illuminated location or at nighttime work. Built-in illuminance sensor automatically turns on/off the lights. Auto-light-off function is also available to turn off these lights automatically if the function switch is not moved or the test button is not pressed for two minutes. The auto-lighting function can be turned off.
- Test probe with remote control switch is supplied as standard accessory
- Shoulder strap for both-hands operation
- User-changeable test prods
- Live circuit warning with blinking LED and buzzer
- Voltage measurement
 - AC/DC auto detection
 - Live circuit warning for a voltage input of 30V or higher
- Insulation resistance measurement
 - With auto-discharge function
When an insulation resistance like a capacitive load is measured, electric charges stored in capacitive circuits are automatically discharged after measurement. Discharge can be checked with the warning LED and buzzer.
 - With alarm function
The LED indicates whether a measured value is less than or higher than the reference value. For further detail, see 8-4. LED insulation status indicator in this manual. This function can be turned off.
 - Safety range between 500V and 1000V ranges
 - Discontinuous warning buzzer sounds when the function switch is set to 1000V range.

3. Specifications

- Measuring range and accuracy ($23^{\circ}\text{C} \pm 5^{\circ}\text{C}$, RH 85% or less)

[Voltage measurement]

Measurement voltage	0 ~ 600V
Accuracy	within $\pm 5\%$ of the maximum scale value

※For an input voltage of 30V or more, the instrument automatically judges AC or DC and indicates the result with the LED.

For AC voltage: Red LED lights up.

For DC voltage: Orange LED lights up.

(The LED doesn't light up if input voltage is less than 30V.)

[Insulation resistance measurement]

Rated measurement voltage	250V	500V	1000V
Max. effective scale value	200M Ω	200M Ω	2000M Ω
Accuracy in first effective measuring ranges	0.1 to 100M Ω		1 to 1000M Ω
	within $\pm 5\%$ of indicated value		
Accuracy in second effective measuring ranges	within $\pm 10\%$ of indicated value ※measuring ranges other than above, 0 and ∞ ticks		
Accuracy at 0 & ∞	within $\pm 0.7\%$ of scale length		
Open-circuit voltage	100% to 120% of rated measurement voltage		
Rated measurement current	1mA, 0% to +20%		
Short-circuit current	within 1.5 mA		

● Applicable standards	<p>● IEC 61010-1, 2-030 CAT III 600V Pollution degree 2</p> <p>● IEC 61557-1, -2</p> <p>● IEC 60529 IP40</p> <p>● IEC 61326-1, 2-2</p> <p>● IEC 61010-031</p> <p>MODEL7260...CAT III 600V (w/ cap) CAT II 1000V (w/o cap) CAT II 1000V (w/ 8017A)</p> <p>(Attach the supplied protective cap to use this test leads in CAT III or higher environments.)</p> <p>MODEL7261A...CAT III 600V (w/ alligator clip) CAT II 600V (w/ flat test bar)</p> <p>(Attach the alligator clip to use this test leads in CAT III or higher environments.)</p> <p>※When test probes, sometimes with metal tips, are connected and used with the instrument, the measurement category and voltage rating of the lowest rated item is applied.</p>
● Location for use	Altitude 2000m or less, in-door use
● Operating temp. & humidity range	0°C to 40°C, 80% or less (no condensation)
● Storage temp. & humidity range	-10°C to 50°C, 75% or less (no condensation)
● Withstand voltage	5160V AC (50/60Hz) / 5 sec Between electrical circuit and enclosure
● Insulation resistance	50MΩ or more/ 1000V DC Between electrical circuit and enclosure
● Auto-power-off	Turns off the instrument automatically, after a beep sound, if there is no function change, range change or button press for about 10 min. (※not work during a measurement)
● Scale light/ LED light	Automatically turns off if there is no activity for about 2 min. (※disabled during a measurement)
● Dimensions	97 (L) × 156 (W) × 46 (H) mm
● Weight	Approx. 430g (including batteries)
● Power source	Four size AA batteries ※Use of alkaline battery is recommended.

● Operating uncertainty (IEC 61557-2)

Operating uncertainty (B) is an error obtained under the nominal operating conditions, and calculated with the intrinsic error (A), which is an error of the instrument used, and the error (En) due to variations. According to IEC61557-2, the maximum operating error should be within $\pm 30\%$. Intrinsic error (A) is uncertainty of the performance characteristics of insulation resistance testers in the reference condition.

※Formula: $B = \pm (| A | + 1.15 \times \sqrt{E_1^2 + E_2^2 + E_3^2})$

A	Intrinsic error
E_1	Influence of position (reference position $\pm 30^\circ$)
E_2	Influence of supply voltage (until red LED battery status indicator lights up)
E_3	Influence of temperature ($0^\circ\text{C} \sim 40^\circ\text{C}$)

The specs of this instrument are as follows.

Intrinsic error (A)within $\pm 5\%$ of indicated value
(coverage factor: $k=2$)

Influence of position (E_1)within $\pm 15\%$ of indicated value

Influence of supply voltage (E_2) ...within $\pm 5\%$ of indicated value

Influence of temperature (E_3)within $\pm 5\%$ of indicated value

Max. operating uncertainty (B) ...24%

※The measuring range to keep the max. operating uncertainty is the same as the 1st effective measuring range.

● Possible number of measurements where battery voltage is within the effective range (measurement of 5 sec., pause of 25 sec.)

Function	Test resistor	Possible number of measurements
250V	0.25M Ω	Approx. 2000 times
500V	0.5M Ω	
1000V	1M Ω	Approx. 1000 times

※in case of using alkaline batteries

4. Instrument layout

(1) Front panel

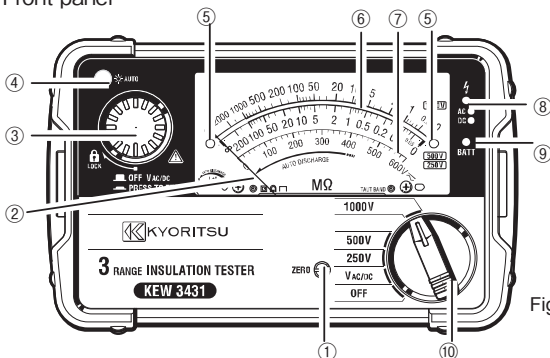

Fig. 4-1

Name	Description
① Meter zero adjuster	Adjusts the pointer position.
② Pointer	Indicates the measured values.
③ Test button	Starts/ stops measurement. For continuous measurement, press and turn the button clockwise to lock it in the operating position.
④ Illuminance sensor	Detects ambient brightness to turn on/ off the lights.
⑤ LED insulation state indicator	Green LED lights up: measured value > preset reference value Red LED lights up: measured value < preset reference value
⑥ Insulation resistance scale	Indicates the measured insulation resistance values. Color coded scales for easy reading.
⑦ Voltage scale	Indicates the measured voltage values.
⑧ Live warning LED	Red LED lights up for AC voltage and orange LED for DC voltage.

⑨	LED battery status indicator	Indicates battery voltage level. Solid green : Enough Blinking green : Low Solid red : Almost exhausted
⑩	Function switch	Switches measurement functions and selects voltage for insulation resistance measurement.

(2) Side panel

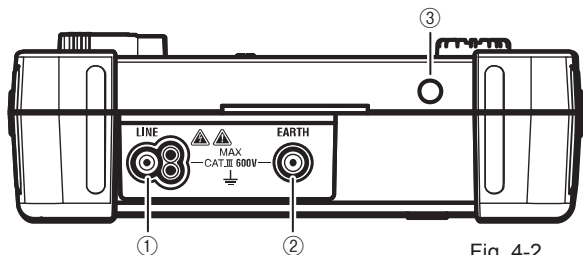

Fig. 4-2

	Name	Description
①	LINE	Terminal for MODEL7260 test lead
②	EARTH	Terminal for MODEL7261A test lead
③	LED light	Illuminates the point to be measured. The light automatically turns on/ off depending on the ambient brightness.

5. Accessories

● Test leads

- (1) Test lead MODEL7260 with remote control switch (red)

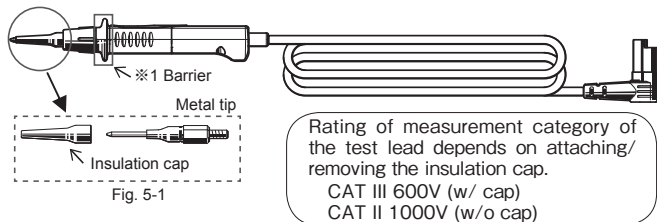

- (2) Extension prod MODEL8017A

※Attached and used with MODEL7260.

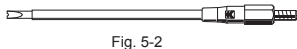

Long type and helpful to access the distant measurement spot

- (3) A set of test leads with alligator clip MODEL7261A

Black cord with banana plugs at both ends

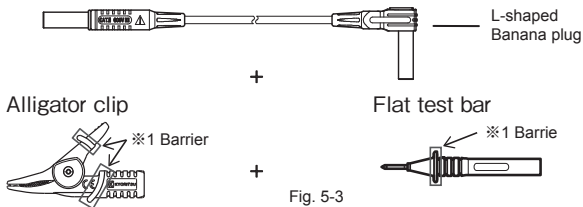

※1 Barrier is a part providing protection against electrical shock and ensuring the minimum required air and creepage distances.

● Other accessories

- (1) Carrying case MODEL9173
- (2) Shoulder strap MODEL9121
- (3) Four size AA alkaline batteries
- (4) Instruction manual

6. Getting started

6-1 Mechanical zero adjustment

With the function switch set to OFF position and without pressing the test button, turn the zero adjuster with a screwdriver so that the pointer lines up with the “∞” mark on the insulation resistance scale. In case the instrument is used at sloping place, ensure that the pointer lines up with the “∞” mark tilting the instrument to the necessary angle.

6-2 Attaching metal tip/ adapter to test leads

The following user-changeable metal tips and adapters are available.

(1) In case of MODEL7260:

The metal tip of MODEL7260 is replaceable depending on the applications.

1. Standard metal tip···Installed at a shipment supplied with detachable insulation cap
2. MODEL8017A ·····Long type and helpful to access the distant

[How to replace the parts]

Turn the tip of MODEL7260 counter-clockwise and remove the metal tip. Insert the metal tip you want to use into the hexagon hole, and turn the tip part of the probe clockwise to tighten firmly.

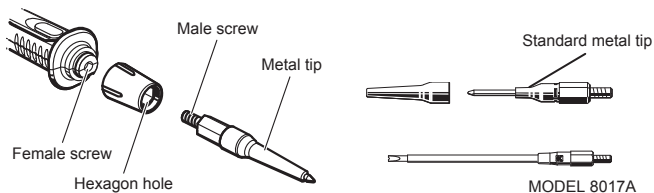

Fig. 6-1

(2) In case of MODEL7261A:

Either of the following adapters can be attached to MODEL7261A.

1. Alligator clip
2. Flat test bar

[How to attach]

Firmly insert and connect the adapter to the end of the cord (with banana plugs at both ends).

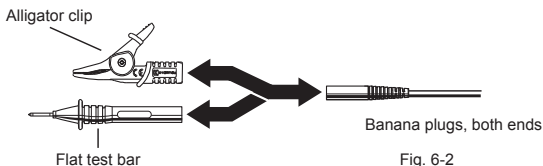

⚠ DANGER

To avoid getting electrical shocks, ensure that test leads are disconnected from the instrument when replacing the metal tip or adapter for test leads.

6-3 Battery voltage check

- (1) Please refer to “11. Battery replacement” in this manual and insert batteries in KEW3431.
- (2) Set the function switch to any position other than OFF to power on the instrument.
- (3) Check the color of LED battery status indicator.

Solid green : Battery voltage is enough.

Blinking green : Battery voltage is low.

Replace batteries with reference to “11. Battery replacement” to perform further measurements.

Solid red : Battery voltage is below the lower limit of the operating voltage. In such a condition, accuracy of the measured result isn't guaranteed. Replace the batteries with new ones as soon as possible.

- Color of LED battery status indicator might change from green to red depending on measured objects; for example, resistance of the measured object is low.
- Use of AA alkaline battery is recommended. Use of other batteries may cause improper indication of battery level.

7. Voltage measurement

⚠ DANGER

- Do not apply a voltage exceeding the maximum allowable input (600V) to the instrument.
- Keep your fingers behind the barrier during a measurement.
- Verify proper operation on a known source before taking actions as a result of the indication of the instrument

7-1 Measurement method

Set the function switch to $V_{AC/DC}$ position to measure voltage.

(1) Connect the test leads as the following figure shows.

- MODEL7260 to Line terminal
- MODEL7261A to Earth terminal

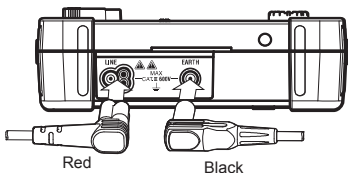

Fig. 7-1

(2) Connect the black test lead to the earth side of the circuit under test and the red remote probe to the line side.

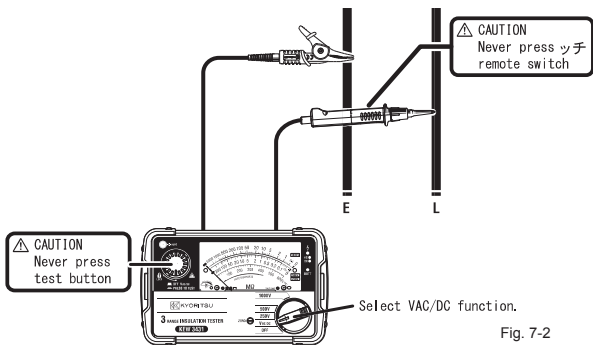

Fig. 7-2

- (3) Check the reading on the LCD without pressing the test or remote control button. The instrument detects AC/DC automatically, and turns on the red LED for ac input and the orange LED for dc input.
- When the measured voltage is less than 30V, AC/DC auto-detect doesn't work.

⚠ CAUTION

The pointer sweeps depending on the applied input even while the instrument is powered off; however, accuracy is not guaranteed. In this state, live warning LED doesn't light up. Ensure the instrument is powered on to measure voltage.

8. Insulation resistance measurement

This instrument is used to measure insulation resistance in electric appliance or circuit to inspect the insulation performance. Check the voltage rating of the object to be tested before making measurement and select the voltage applied to.

Note:

- Depending on the object to be measured, displayed insulation resistance value may not stabilize.
- The instrument may give bleep during an insulation resistance measurement, however, this is not a malfunction.
- Measurement time may be longer when measuring capacitive load.
- In insulation resistance measurement, the earth terminal outputs positive voltage and the line terminal negative voltage.
- Connect the earth cord to the earth (ground) terminal at measurement. It is recommended to connect the positive side to the earth side when measuring insulation resistance against ground or when a part of the object under test is earthed. Such connection is known to be more suitable for insulation testing since insulation resistance values measured with the positive side connected to earth are typically less than those taken through the reversed connection.

DANGER

- Be extremely careful not to touch the tip of test probe or circuit under test to avoid electrical shock during insulation measurement as high voltage is present on the tip of the test probe continuously. Wipe the test probe with a soft cloth, if it is wet, and use it after it's dry.
- Never make measurements with the battery compartment cover removed.

CAUTION

Always disconnect power to the conductor under test before starting insulation measurement. Do not attempt to make measurements on a live conductor. Otherwise, it may damage the instrument.

8-1 Measurement method

- (1) Connect the test leads as the following figure shows.
 - MODEL7260 to Line terminal
 - MODEL7261A to Earth terminal

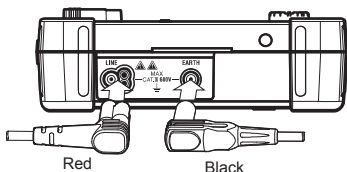

Fig. 8-1

- (2) Confirm the circuit under test is not energized, and measure voltage with reference to “7. Voltage measurement” .
- (3) Confirm the voltage value which can be applied to the object under test, and then set the function switch to a desired range.
 - There is an empty range between 500V and 1000V for safety purpose. If the function switch is set to this safety position, the instrument doesn't start a measurement although the test button is pressed down.
 - Discontinuous warning buzzer sounds when the function switch is set to 1000V range.
- (4) Connect the earth test lead (MODEL7261A) to the earth terminal of the circuit under test. The live warning LED blinks and buzzer sounds if a voltage of 30V or higher exists in the circuit. Pressing the test button in this state doesn't start resistance measurement.
- (5) Place the tip of remote probe (line) to the circuit under test and press the test button or remote control switch.

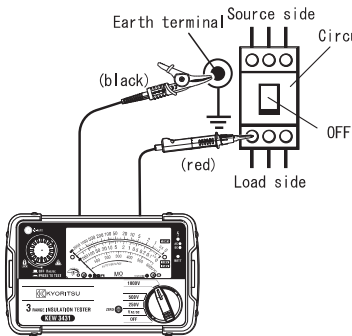

Fig. 8-2

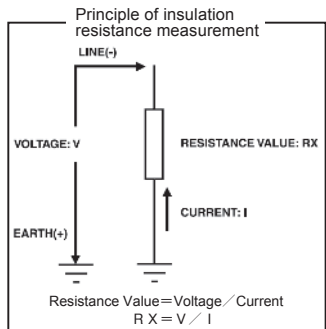

Fig. 8-3

(6) Auto discharge function

This function allows electric charges stored in the capacitance of the circuit under test to be automatically discharged after measurement. Set the test button or remote control switch to off with the test leads connected. Discharge can be checked with the meter, blinking LED and buzzer.

[Display example]

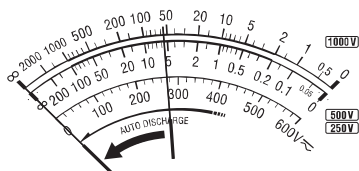

Fig. 8-4

(7) Power off the instrument when measurement completes, and disconnect the test leads.

8-3 Output voltage characteristics

This instrument conforms to IEC61557. This standard defines that the nominal current shall be at least 1mA, and the lower limit of the insulation resistance maintaining the nominal voltage at the measurement terminal. (See the graph below.) This value is calculated by dividing the nominal voltage by nominal current. i.e., in case that the nominal voltage is 500V, the lower limit of the insulation resistance is found as follows.

Divide 500V by 1mA equals 0.5M Ω .

That is, insulation resistance of 0.5M Ω or more is required to provide the nominal voltage to the instrument.

Nominal voltage	250V	500V	1000V
Lower limit of the insulation resistance to provide the nominal current of 1mA	0.25 M Ω	0.5 M Ω	1 M Ω

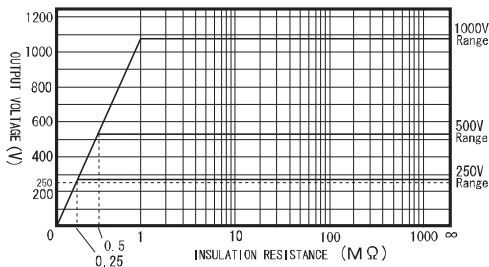

Fig. 8-5

8-4 LED insulation status indicator

KEW3431 has insulation status check function. In an insulation measurement, the measured value is compared to the pre-set reference value, and either red or green LED lights up according to the result. This function can be turned off. See “10. How to disable LED insulation status indicator & auto-lighting” in this manual for detail.

Reference values for each range

Nominal voltage	250V	500V	1000V
Reference value	0.25M	0.5M	1M

Reference values are determined based on the resistance value to provide 1mA with the nominal voltage. The color of LED indicates the result as follows.

Compared result	LED insulation status indicator
> reference value	Solid green
< reference value	Solid red

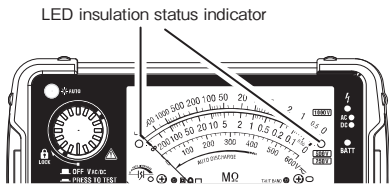

Fig. 8-7

9. Scale light and LED light

The illuminance sensor on this instrument detects ambient brightness and automatically turns on/ off the scale light and LED light. Once these lights turn on, they stay on for about 15 sec. This auto-lighting function can be turned off. See “10. How to disable LED insulation status indicator & auto-lighting” in this manual for detail.

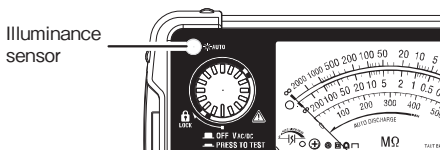

Fig. 9-1

- Keep the surface of the illuminance sensor clean to ensure proper detection of brightness.
- The sensitivity of the sensor is not adjustable. Cover the sensor with your finger to turn on the light manually.
- These lights turn off automatically if the function switch is not moved or the test button is not pressed for two minutes. (These lights don't turn off automatically during a measurement.)

10. How to disable LED insulation status indicator & auto-lighting

1. Get the instrument into configuration mode, to disable the LED insulation status indicator and auto-lighting of scale light and LED light.
 - (1) Cover the illuminance sensor with your finger and turn the function switch from OFF to V_{AC/DC} position and power on the instrument.
 - (2) Press the test button five times within three seconds after the LED battery status indicator lights up to get the instrument into configuration mode. Buzzer sounds intermittently while the instrument is in this mode.

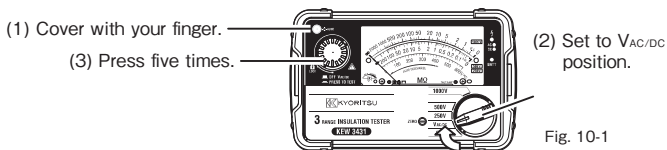

Fig. 10-1

2. Press the test button to toggle settings. (The following four settings are available.)

Settings	Mode			
	1	2	3	4
LED insulation status indicator	ON	OFF	ON	OFF
Scale light/ LED light	ON	ON	OFF	OFF

The color of the LED indicates the currently selected mode.

- LED insulation status indicator:

Blinking green means “ON” and not lighting up means “OFF” .

- Scale light/ LED light:

Blinking light means “ON” and not lighting up means “OFF” .

Blinks when "ON" has been selected for scale light / LED light.

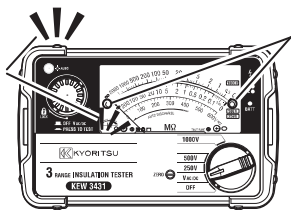

Blinks when "ON" has been selected for LED insulation status indicator.

Fig. 10-2

3. The instrument exits from configuration mode when it is powered off but retains the selected setting.

It may difficult to get the instrument in configuration mode in outdoor even the sensor is covered with your finger.

11. Battery replacement

Replace batteries with new ones when the red LED battery status indicator lights up.

⚠ DANGER

- Do not open the battery compartment cover if the instrument is wet.
- Never attempt to replace batteries during a measurement. In order to avoid getting electrical shock, ensure that the instrument is powered off and test leads are disconnected from the instrument before replacing batteries.
- The battery compartment cover must be closed and screwed before starting a measurement. Otherwise, electrical shock hazard may be caused.

⚠ CAUTION

- Do not mix new and old batteries or mix different types of batteries.
- Install batteries in correct polarity as marked inside.

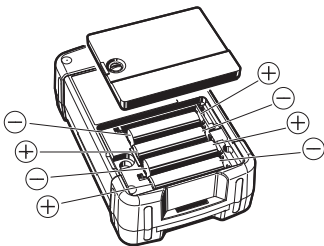

Fig. 11-1

- (1) Power off the instrument, and then disconnect the test leads.
- (2) Loosen one screw which is fixing the battery compartment cover, and remove the cover.
- (3) Replace all four batteries with new ones at the same time. Be sure that the battery polarity is correct.

Use of four size AA alkaline batteries (LR6) is recommended.

- (4) Install the battery compartment cover, and tighten one screw for the cover.

12. Shoulder strap belt attachment

This instrument is equipped with a strap to suspend from the neck to allow both hands to be used freely for easy and safe operation.



Fig. 12-1

13. Storing in Carrying case

Store the instrument and test leads as the following figure shows.

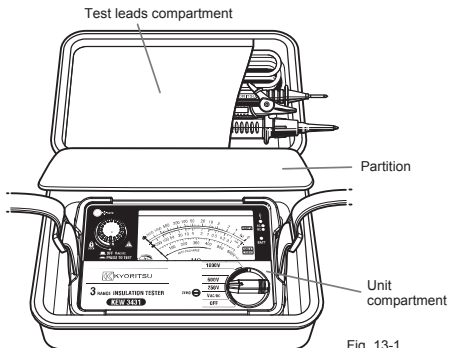

Fig. 13-1

⚠ CAUTION

Ensure that the instrument is powered off before storing in the carrying case.

14. Cleaning meter cover

This instrument is managed by our company's quality standard and is delivered in the best condition after passing the inspection. But in the dry time of winter static electricity sometimes builds up on the meter cover due to the characteristics of plastic.

When static builds up on the meter cover and affects the meter reading, use a cloth damped with off-the shelf anti-static agent or detergent to wipe the meter cover surface.

CAUTION

- When the pointer deflects by touching the surface of this instrument or zero adjustment cannot be made, do not try to make measurement.
- Antistatic agent has been applied to the meter cover of the instrument for electrification prevention, therefore, do not rub it strongly with a dry cloth etc. even if it is dirty.
- To avoid possible deforming or discoloring, do not use solvents.

DISTRIBUTOR

Kyoritsu reserves the rights to change specifications or designs described in this manual without notice and without obligations.



KYORITSU ELECTRICAL INSTRUMENTS WORKS, LTD.

2-5-20, Nakane, Meguro-ku,

Tokyo, 152-0031 Japan

Phone: +81-3-3723-0131

Fax: +81-3-3723-0152

Factory: Ehime, Japan

www.kew-ltd.co.jp